

1A SCRs

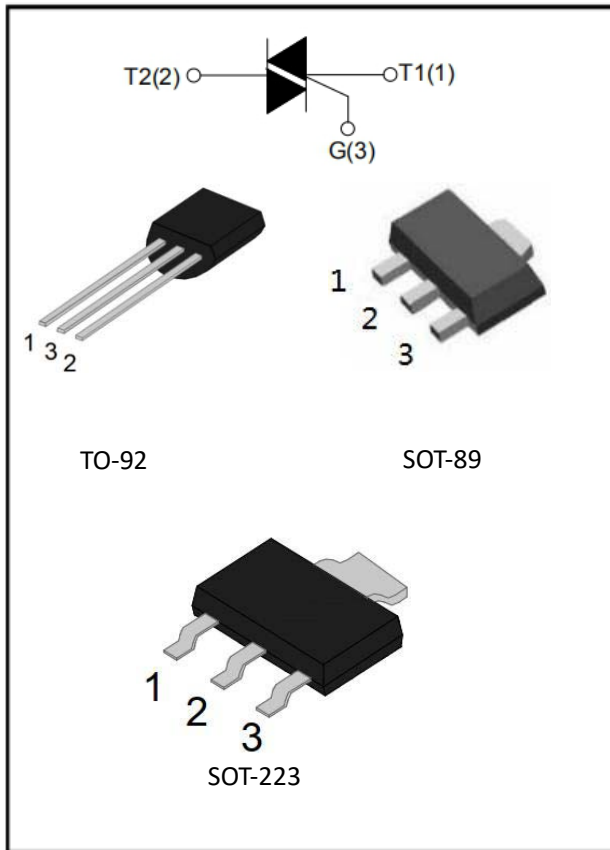

Features

- On-state rms current, $I_{T(RMS)}$ 1 A
- Repetitive peak off-state voltage, V_{DRM}/V_{RRM} 800 V
- Triggering gate current, $I_{GT(Q1)}$ 5 mA

Applications

- General purpose switching and phase control
- General purpose low power switching
- Solid-state relay

Mechanical Data

- Case Material: "Green" Molding Compound
- Package:

DEVICE	PACAKGE
ACY0810S2	SOT-223
ACY0810S3	SOT-89
ACY0810T9	TO-92

Main Characteristics

SYMBOL	LIMITS	UNIT
$I_{T(RMS)}$	1	A
V_{DRM}/V_{RRM}	800	V
I_{GT}	5	mA

Maximum Ratings

PARAMETER	SYMBOL	LIMITS	UNIT
Storage junction temperature range	Tstg	-40~150	°C
Operating junction temperature range	Tj	-40~125	°C
Repetitive surge peak Off-state voltage (Tj=25°C)	V_{DRM}	800	V
Repetitive peak reverse voltage (Tj=25°C)	V_{RRM}	800	V
RMS on-state current (TC=80°C)	$I_{T(RMS)}$	1	A
Non-repetitive surge peak on-state current (full cycle, F=50Hz)	I_{TSM}	16	A
I^2t value for fusing (tp=10ms)	I^2t	1.28	A ² s
Critical rate of rise of on-state current ($I_G=2 \times I_{GT}$)	di/dt	I - II - III	50
		IV	10
Peak gate current	I_{GM}	2	A
Average gate power dissipation	$P_{G(AV)}$	0.5	W
Peak gate power	P_{GM}	5	W



ACY0810 Series

■Electrical Characteristics (T_a=25°C Unless otherwise specified)

PARAMETER	SYMBOL	UNIT	TEST CONDITIONS	QUADRANT	MIN	TYP	MAX
Gate trigger current	I _{GT}	mA	V _D =12V, R _L =33Ω	I - II - III			5
				IV			10
Gate trigger voltage	V _{GT}	V	V _D =12V, R _L =33Ω	I - II - III - IV			1.3
Non-triggering gate voltage	V _{GD}	V	V _D =V _{DRM}	I - II - III - IV	0.2		
Holding current	I _H	mA	I _T =100mA	I - II - III - IV			7
Latching current	I _L	mA	I _G =1.2 I _{GT}	I - III - IV			5
				II			20
Rate of rise of off-state voltage	dV/dt	V/μs	V _D =0.66×V _{DRM} T _j =125°C Gate open	I - II - III - IV	50		

■Thermal Characteristics (T_a=25°C Unless otherwise specified)

PARAMETER	SYMBOL	UNIT	TEST CONDITIONS	MAX
Peak on-state voltage	V _{TM}	V	I _{TM} =1.4A t _p =380μS	1.5
Peak off-state current Peak reverse current	I _{DRM} I _{RRM}	μA	V _{DRM} = V _{R_{RM}} , T _j =25°C	5
		mA	V _{DRM} = V _{R_{RM}} , T _j =125°C	0.5

■Thermal Resistance (T_a=25°C Unless otherwise specified)

PARAMETER	SYMBOL	UNIT	Pacakge	Value	
Thermal Resistance (Typical)	Junction to case	R _{θJ-C}	°C/W	TO-92	60
			°C/W	SOT-89/SOT-223	31



■ Characteristics (Typical)

FIG.1: Maximum power dissipation versus RMS on-state current

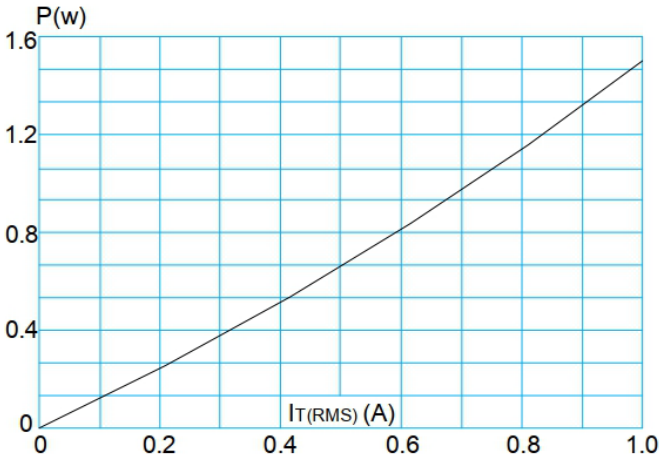

FIG.2: RMS on-state current versus case temperature

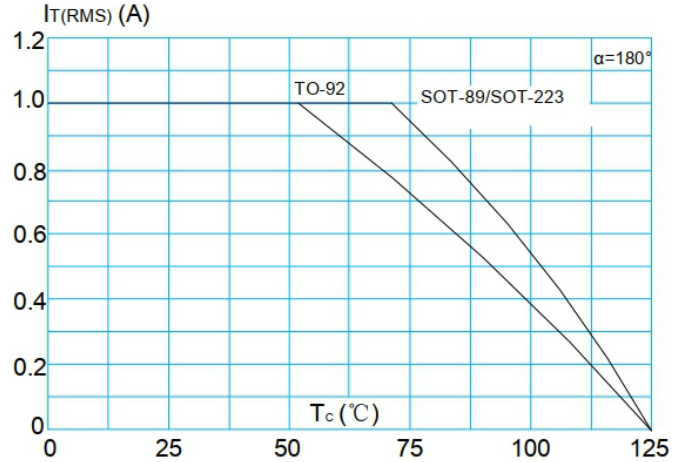

FIG.3: Surge peak on-state current versus number of cycles

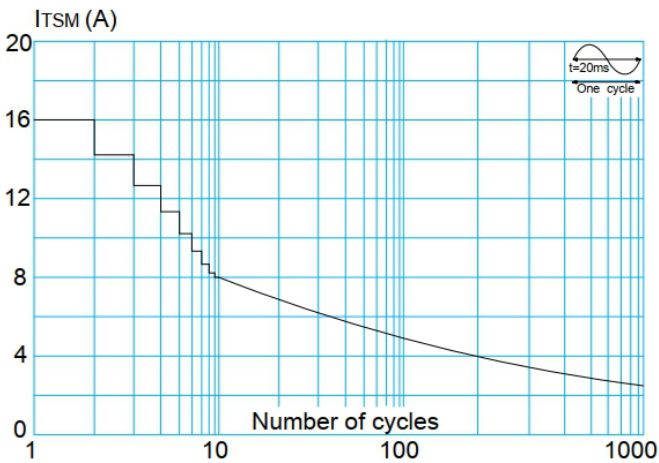

FIG.4: On-state characteristics (maximum values)

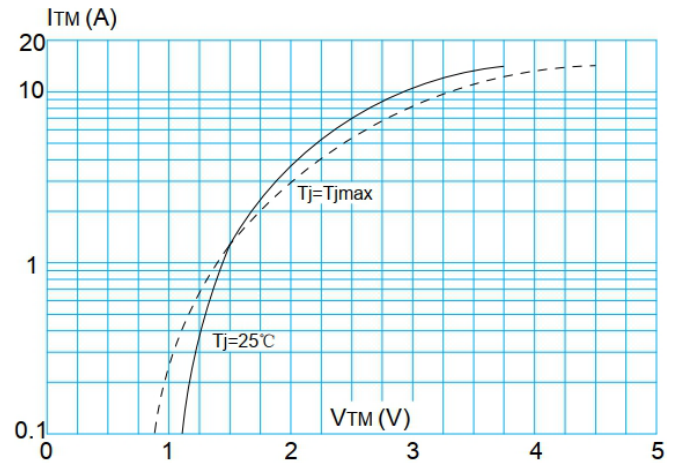

FIG.5: Non-repetitive surge peak on-state current for a sinusoidal pulse with width $t_p < 20\text{ms}$, and corresponding value of $I_2 t$ ($di/dt < 50\text{A}/\mu\text{s}$)

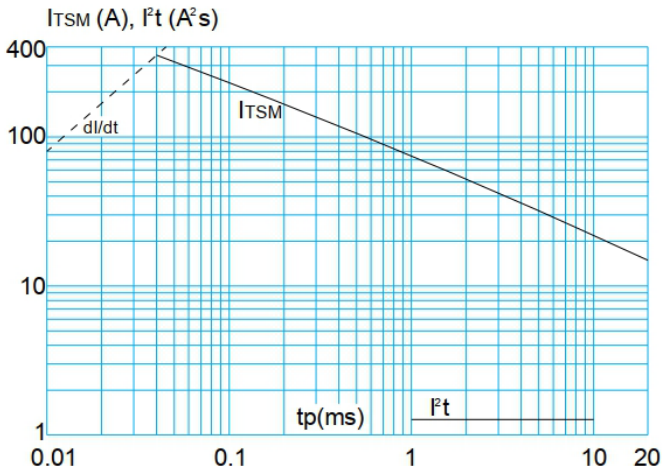
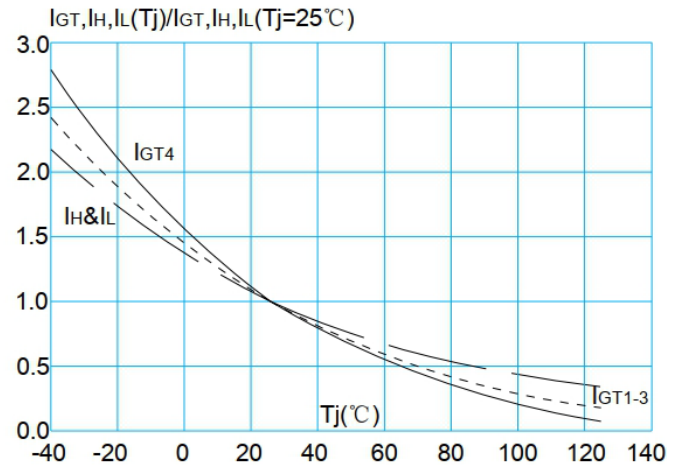

FIG.6: Relative variations of gate trigger current, holding current and latching





ACY0810 Series

■ Outline Dimensions

➤ SOT-223 Package Outline Dimensions

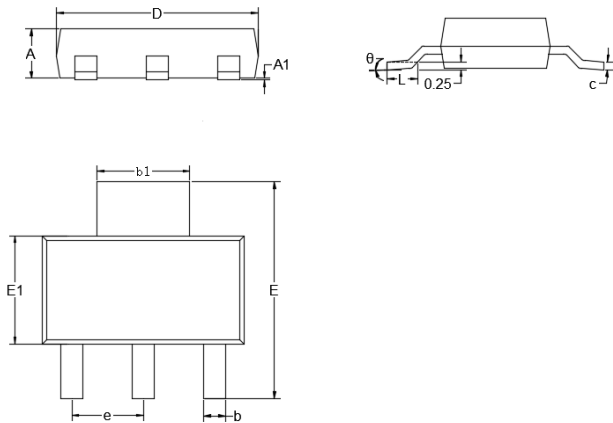

DIM	DIMENSIONS			
	INCHES		MM	
	MIN	MAX	MIN	MAX
A	0.0591	0.0670	1.5000	1.7000
A1	0.0008	0.0039	0.0200	0.1000
b	0.0259	0.0330	0.6600	0.8400
b1	0.1140	0.1220	2.9000	3.1000
c	0.0090	0.0138	0.2300	0.3500
D	0.2480	0.2640	6.3000	6.7000
E	0.2637	0.2874	6.7000	7.3000
E1	0.1290	0.1460	3.3000	3.7000
e	0.0866	0.0945	2.2000	2.4000
L	0.0295	0.0492	0.7500	1.2500
θ	0°	10°	0°	10°

SOT-223 Suggested Pad Layout

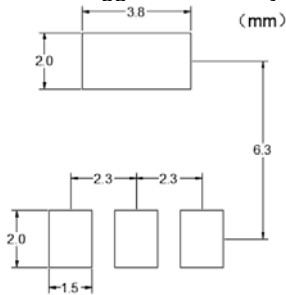

➤ SOT-89 Package Outline Dimensions

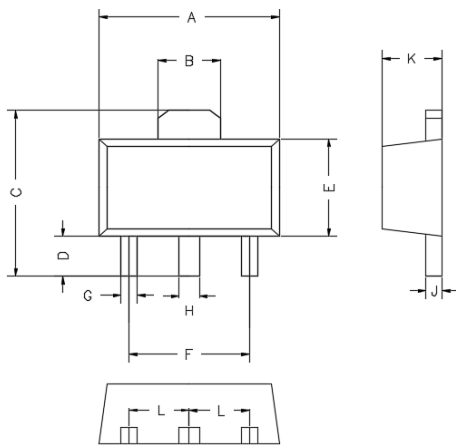

DIM	DIMENSIONS				NOTE
	INCHES		MM		
	MIN	MAX	MIN	MAX	
A	0.169	0.185	4.30	4.70	
B	0.061		1.55		TYP
C	0.154	0.171	3.91	4.35	
D	0.031	0.047	0.80	1.20	
E	0.089	0.104	2.25	2.65	
F	0.118		3.00		TYP
G	0.013	0.020	0.33	0.52	
H	0.016	0.023	0.40	0.58	
J	0.014	0.017	0.35	0.44	
K	0.055	0.063	1.40	1.60	
L	0.059		1.50		TYP

SOT-89 Suggested Pad Layout

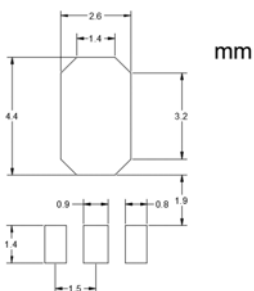



ACY0810 Series

➤ TO-92 Package Outline Dimensions

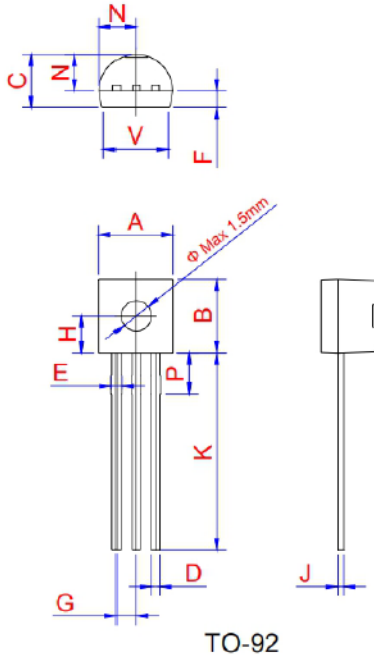

Ref.	Dimensions					
	Millimeters			Inches		
	Min.	Typ.	Max.	Min.	Typ.	Max.
A	4.45	4.6	5.2	0.175	0.181	0.205
B	4.32	4.6	5.33	0.17	0.181	0.21
C	3.18	3.55	4.19	0.125	0.14	0.165
D	0.407		0.533	0.016		0.021
E	0.6		0.8	0.024	0	0.031
F	-	1.1	-	-	0.043	-
G	-	1.27	-	-	0.05	-
H	-	2.3	-	-	0.091	-
J	0.36	0.38	0.5	0.014	0.015	0.02
K	12.7		15	0.5		0.591
N	2.04	2.3	2.66	0.08	0.091	0.105
P	1.86		2.06	0.073		0.081
V	-		4.3	-		0.169

■ Marking Information

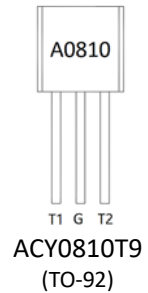
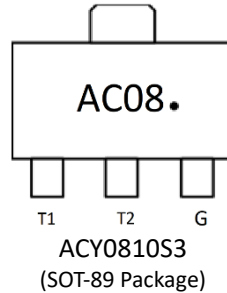
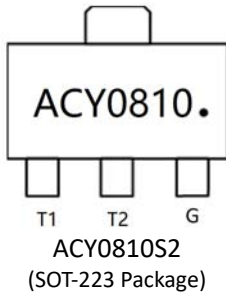

Disclaimer

The information presented in this document is for reference only. Yangzhou Yangjie Electronic Technology Co., Ltd. reserves the right to make changes without notice for the specification of the products displayed herein to improve reliability, function or design or otherwise.



ACY0810 Series

The product listed herein is designed to be used with ordinary electronic equipment or devices, and not designed to be used with equipment or devices which require high level of reliability and the malfunction of which would directly endanger human life (such as medical instruments, transportation equipment, aerospace machinery, nuclear-reactor controllers, fuel controllers and other safety devices), Yangjie or anyone on its behalf, assumes no responsibility or liability for any damages resulting from such improper use of sale.

This publication supersedes & replaces all information previously supplied. For additional information, please visit our website [http:// www.21yangjie.com](http://www.21yangjie.com) , or consult your nearest Yangjie's sales office for further assistance.